

1001 Bronze Globe Valve (Screwed)

Salient Features

- Screwed Female Ends to IS 554 / BS 21 / ISO 7.
- Screwed in Bonnet, Inside Screw, Rising Stem, Integral Seat.
- Designed sheet metal handwheel for a firm grip and convenient operation.
- Premium Quality PTFE Gland Packing.
- Medium Pattern.

Test Pressure (Hydrostatic) :
Shell : 20 kg/cm²g (285 psig)
Seat : 13.50 kg/cm²g (192 psig)
Maximum Working Temperature : 225°C

Suitable For

Water, Oil, Air*, Gases*

*Also available with PTFE Seating for Air and Gas applications, at a nominal extra price.



Materials

P.No.	Name of Part	Material of Construction	Specification	Quantity
1	Screw / Bolt	Carbon Steel (Zinc Plated)	---	1
2	Washer	Carbon Steel (Zinc Plated)	---	1
3	Handwheel	Sheet Metal (Powder Coated)	---	1
4	Stem	Forged Brass	IS 6912 Gr. FLB	1
5	Gland Nut	Forged Brass	IS 6912 Gr. FLB	1
6	Gland	Forged Brass	IS 6912 Gr. FLB	1
7	Gland Packing	PTFE	---	-
8	Bonnet	Bronze	IS 318 Gr. LTB2	1
9	Body	Bronze	IS 318 Gr. LTB2	1
10	Disc	Bronze	IS 318 Gr. LTB2	1
11	Disc Nut	Bronze	IS 318 Gr. LTB2	1
12	Name Plate	Aluminium	---	1

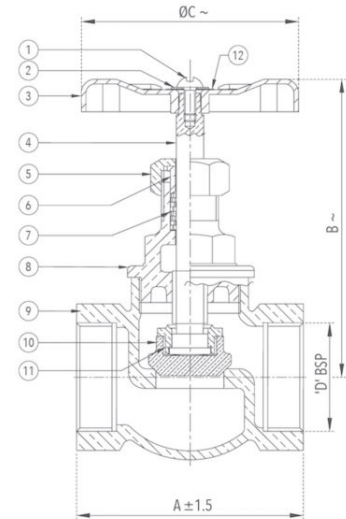

Sizes / Dimensions

Size (Inches)	Size (mm)	A ±1.5	B ~	ØC ~	D
1/4	8	33	60	50	1/4"
3/8	10	37	60	50	3/8"
1/2	15	45	70	60	1/2"
3/4	20	53	85	65	3/4"
1	25	57	93	70	1"
1 1/4	32	71	109	80	1 1/4"
1 1/2	40	80	117	90	1 1/2"
2	50	86	137	110	2"
2 1/2	65	107	154	120	2 1/2"
3	80	123	184	140	3"
4	100	159	224	160	4"

~ ±10